

The Railyard Local

Volume 12, Issue 1

-The Monthly Newsletter of the Danbury Railway Museum-

February-March 2013

DRM Receives Amherst Grant

While the DRM attended Amherst Railway Society's giant Railroad Hobby Show in West Springfield, MA, the Museum was awarded \$2000 to be used toward restoration of the Rutland wooden boxcar in our railyard. DRM President Wade Roese and DRM Treasurer Patty Osmer represented the Museum at the ceremony on January 27th during the event. As the photos show, Wade received the check from Amherst's President Sudro Brown, then immediately handed it to Patty, who looks immensely pleased to receive it!

Many thanks to Steve Gould, Jerry Lawlor and Mike Salata of the DRM's Grants Committee for submitting our application for this and other grants on behalf of the Museum.



Photo above shot by Tom McCullough. Below, photo taken by Alan Gruber.



Amherst generously uses proceeds from its show to help fund endeavors by numerous railroad related non-profit organizations. To date this organization has distributed over \$750,000 in funds. The Danbury Railway Museum also has been a recipient of very helpful Amherst grants previously. Thank you!

In This Issue

- ~ Words from Our President -Page 3
- ~ DRM at "Big E" for Railroad Hobby Show - Page 6
- ~ Calendar of Events 2013 - Page 7
- Plus . . . Ten Years Ago and New Members

Staying on the Track and the Three Point Stance

Some steam locomotive history

By Bob Boothe

What do a football lineman and our Boston and Maine 1455 locomotive have in common? They both use a "three point stance" for stability, power, and balance.

In this era of Acela, Bullet Trains, and other forms of high speed rail service we tend to forget that in the early days of steam railroad history the seemingly simple issue of locomotives "staying on the rails" was a MAJOR technological problem which needed to be solved. The three point stance turned out to be the solution.

One of the things on the "to do" list for the 1455 Preservation Project is to identify ALL the locations and fittings which require lubrication. As a result I have literally been crawling around and under the 1455 to identify the spots. In the process I have come across a number of levers, hinges and pivot points. I

Continued on Page 4

Annual Meeting March 20th Election results, reports + program

We hope you will join us for the DRM's Annual Meeting. Light refreshments (i.e., hors d'oeuvres and finger foods) will be available. The Museum's officers will deliver their reports covering this past year and goals for 2013. Project leaders also will give updates. Steve Gould will announce the results of this year's contested election of directors and officers for the Board. Following this there will be a short program of entertainment.

The deadline for the Museum's receipt of ballots for the election is 7:30pm on Wednesday, March 20th. There will be no exceptions. If you have not received your ballot, please notify the Museum immediately!

Spring Brings the Bunny

Easter Bunny Express March 23, 24, 29, 30

Our very popular family event will be starting soon! Please spread the word. Once again the Bunny will greet families in the coach specially decorated for the occasion to delight everyone coming aboard. Decorations will be found throughout the Museum and railyard.



The DRM's vintage train will be departing every 1/2 hour 12:30-3:30pm. Children will receive a small gift from the Bunny and find entertainment at the play tables, four scales of operating model train layouts, temporary tattoos, coloring station, Gift Shop, displays, and tours of the railyard. Admission will be \$9 for ages 2 and over; under 2 free. Museum hours will be 10-4:30 Friday and Saturday during the event, noon-4:30 on the Sunday. Due to its popularity, reservations are recommended to avoid disappointment or waiting. Try reserving online at www.danburyrail.org or call the Museum at (203) 778-8337.

Sue Teer would love some assistance with decorating in the railyard. If you can help on Wednesday, March 20th or Thursday, March 21st please call her at (203) 792-1981 or email her at eventlady@att.net.

Car Hosts and Tour Guides

Training program 10:30am Sat. March 16th

Volunteers wishing to be Car Hosts or Tour Guides, in addition to passing the Safety Exam, must attend a training program. This will last about one hour. Topics will include how to enhance our guests' experience at the DRM, safety issues, and questions or topics participants of this session would like addressed. If you are unable to attend, please contact

Steve Gould, Peter McLachlan or John O'Hern to make alternate arrangements.

2

Ten Years Ago

By Stan Madyda

With the 2002 season completed the Museum was looking forward to a new year and new opportunities.

In the station, the layouts were receiving much attention and continued growth. The Jack Swanberg photo exhibit "A Railroad at Work, The New Haven Railroad 1956-1966" was proving to be very popular with our visitors.

Plans were being made for the Spring 2003 show to be held at the Museum. In the past, vendors were allowed to set up in the Museum and outside, but more floor space was being used inside the station for our layouts and exhibits. It was decided to move the train show dealers to the gymnasium at WestConn. A shuttle would be provided for visitors to get back and forth between the two locations.

In addition to the annual train show, 2003 marked the 100th anniversary of the opening of the station and a two day event was being planned for July. The Gift Shop offered a special Athearn box car to commemorate the event.

As always there was much work being planned for outside in the yard. Equipment needed ongoing maintenance and restoration and project leaders were lining up help to get started once the weather got warmer. Areas in the yard were identified where track-work would need to be done.

New Members

We are delighted to welcome our new members this month. All members, as well as the general public, are welcome to attend the weekly meetings and free programs held Wednesdays, 7:30pm, at the Museum, 120 White Street, Danbury. We invite all members to become involved in Museum activities as soon as possible!

Have you noticed? The address label on each newsletter indicates the expiration date of your membership. (If you have very recently renewed your membership the new date may not be reflected yet on the label). The membership of Life Members does not have an expiration date.

Jeremy Mikesell
Craig Ungaro
Kenneth Makowski
Claudine Collet
Shirin Pagels
Aimee Peters
Wendy Natter
Abigail Cross
Chris Sheridan

Danbury, CT
Ridgefield, CT
Danbury, CT
New Milford, CT
Woodbury, CT
Redding, CT
Danbury, CT
Yorktown Heights, NY
Yonkers, NY

Words from Our President

Warmer weather is coming (I hope).

This past year 2012 we continued work on many projects, started some new ones and thought about others. Now 2013 is here and we are looking for things to do and volunteers to assist. Following is a list of current projects on our plate:

RS-1 maintenance
Tonawanda Valley coach
44 tonner operational
Botsford water tower
volunteer IDs
FL-9 stairs
Rutland box car
newsletter
building cleanup
RS-11

Vermont flat car restoration/ride on
NYC caboose
G-gauge layout
turntable pit
SW-8
NH caboose painting
speeder
yard work
landscaping in yard
events

burro crane
44 tonner paint
turntable ring rail
forge expansion
RDC #32
MU cars
Library
track work
1455

New ideas, your thoughts and suggestions

Your input, concerns and volunteer help are needed and, as always, are appreciated. If you can or would like to help with a project, would like to know more about a project, or just want to discuss a project, please talk with us. Volunteers, always wanted and needed, keep us moving forward. Please hop aboard!

On behalf of the DRM,
Wade Roesse

Trackwork Volunteers Needed

By Jim Teer, Project Leader

The DRM will need **trackwork volunteers** on the **first Saturday of each month April-October beginning at 9:30am**. Please bring your own safety vest or belt, or we will provide you with one. You must pass the safety test this year prior to working in the railyard. John O'Hern can administer it any Thursday or Saturday. If you have any questions, please call Jim at (203) 885-2064 or send an email to eventlady@att.net.



Help Needed

By Stan Madyda, Project Leader

As Project Leader of the Metro-North ACMUs, I would like to see if I can get some help cleaning the cars out and stabilizing them. Next steps would be to prepare them for eventual painting back into as-delivered New York Central. Please contact me at the Museum or at smadyda@yahoo.com if you are interested.



The two ACMUs just after arrival in the DRM railyard in November 2005.

have discovered that many of them have to do with this “3 point stance” system, which in turn was one reason the 2-6-0 mogul was such a popular workhorse in its day. In fact, the principles you see on the 1455 can also be seen on steam locomotives up through the era of the “superpowered” engines. Here is a brief summary of how this all came about and what to look for.

At right, 0-4-0 Best Friend (1830)

0-4-0 Locomotive (Transition Era)

The American mechanics and entrepreneurs of early railroads (1825-1830) quickly learned that steam locomotives (English imports or American made) with four driving wheels (0-4-0's) were prone to derailing on the rough and often irregular track. The first three locomotives built in America (starting in 1829 at the West Point Foundry in Cold Springs NY) were indeed 0-4-0's.

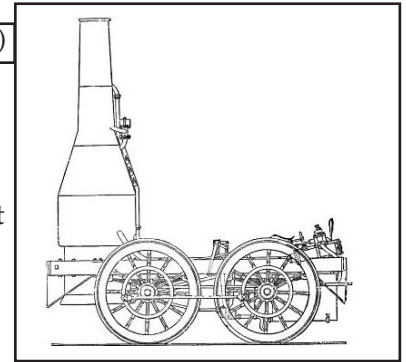

4-2-0 Locomotive (“Jervis” Type)

In 1832 the Foundry built its 4th locomotive, (aptly named the “Experiment”), built and designed by John Jervis, the former head engineer for the Erie Canal. It was a 4-2-0. He replaced the forward pair of driving wheels with a four-wheel non-powered swiveling truck. The remaining two rear wheels (the 2 in the 4-2-0) were driving wheels and each had its own suspension (ie right and left stool legs). The four-wheeled front truck (with its own springing) carried the front of the engine (the third leg of the stool). Thus the 4-2-0 established the principle of the “three legged stool” for steam locomotive suspension systems. Put simply, a stool with three legs will always be stable even on uneven ground. Since American track was notorious for its “ups and downs”, creating a “three legged stance” for steam locomotives became an objective for all subsequent American steam locomotive designs. Jervis never patented his idea, so it “took off”. Hundreds of these 4-2-0's were made from 1835 to 1842, but soon it became apparent that more tractive power (ie, driving wheels) was needed.

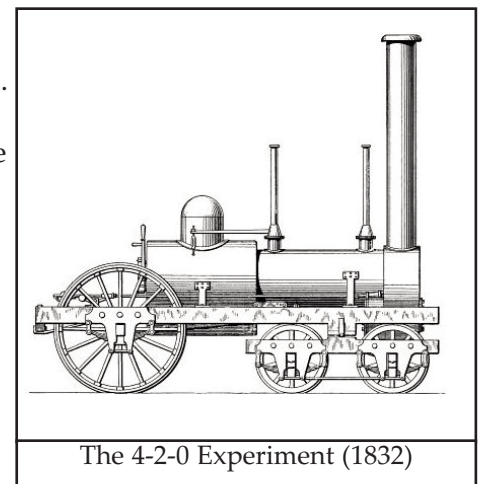

4-4-0 Locomotive (“American” Type)

Though some builders simply added a second set of driving wheels, in 1839 the firm of Eastwick and Harrison patented the idea of equalizing the suspension systems of each pair of the 4 driving wheels. The back weight of each side of the locomotive rested on a fulcrum of an equalizing bar to which were attached the ends of the leaf springs connected to the bearing boxes for the drive wheel axles. Thus each wheel could respond to the undulations of the track yet provide constant support for the locomotive (at the equalizer fulcrum). The heavy firebox rode nicely between the pairs of driving wheels. Just like the football lineman, the driving wheel pairs (ie., the player's right and left legs) supplied the power, while the front truck (his forward ground hand) provided the balance. Thus was born the first generation of the American type 4-4-0 which we associate with the Civil War, the Great Locomotive Chase, and the Transcontinental Railroad.

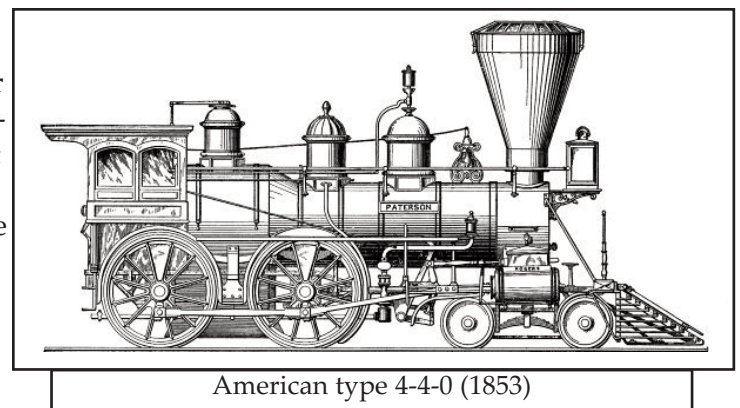

We can see on the 1455 (Fig 1) just such an equalizing system for the rear 2nd, and 3rd driving wheels. You can follow the mechanical linkage in the section of the erecting show drawing (Fig 2) we were given by the BMRHS and colored in by Alan LePain. Alan also created a “3- D” rendering of most of the components as seen in Fig 3. Finally, Fig 4 is an illustration of this “see saw” equalizing lever in action as the two driving wheels go over a section of depressed (exaggerated) track.

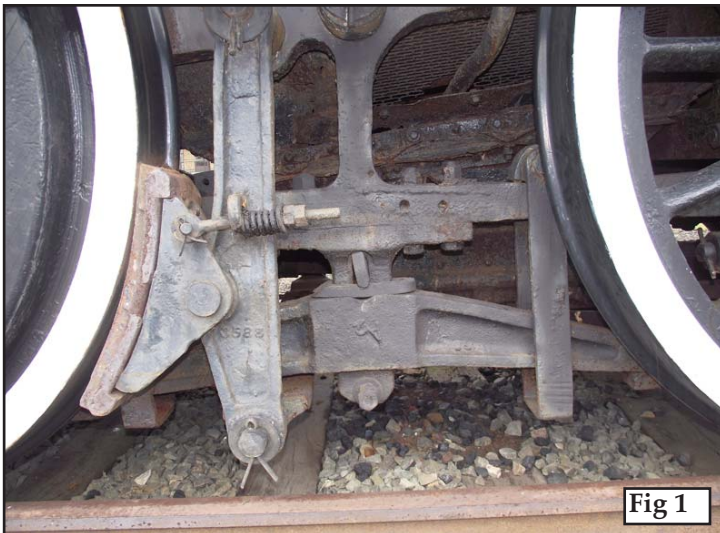

Fig 1

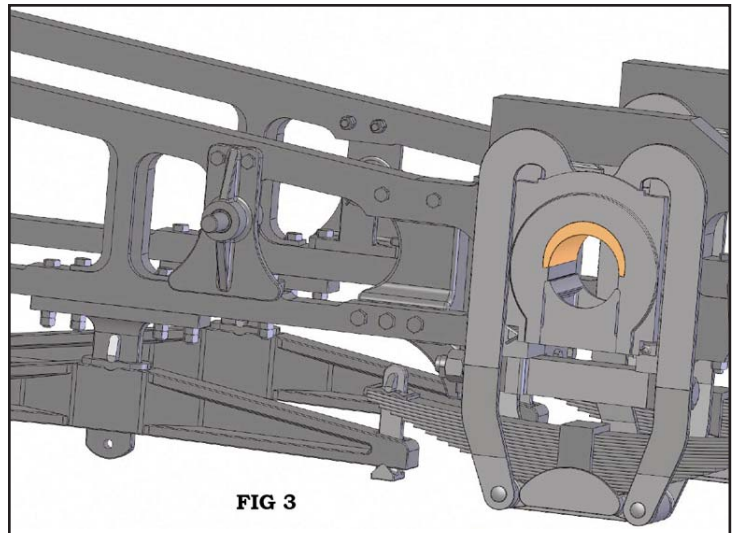

FIG 3

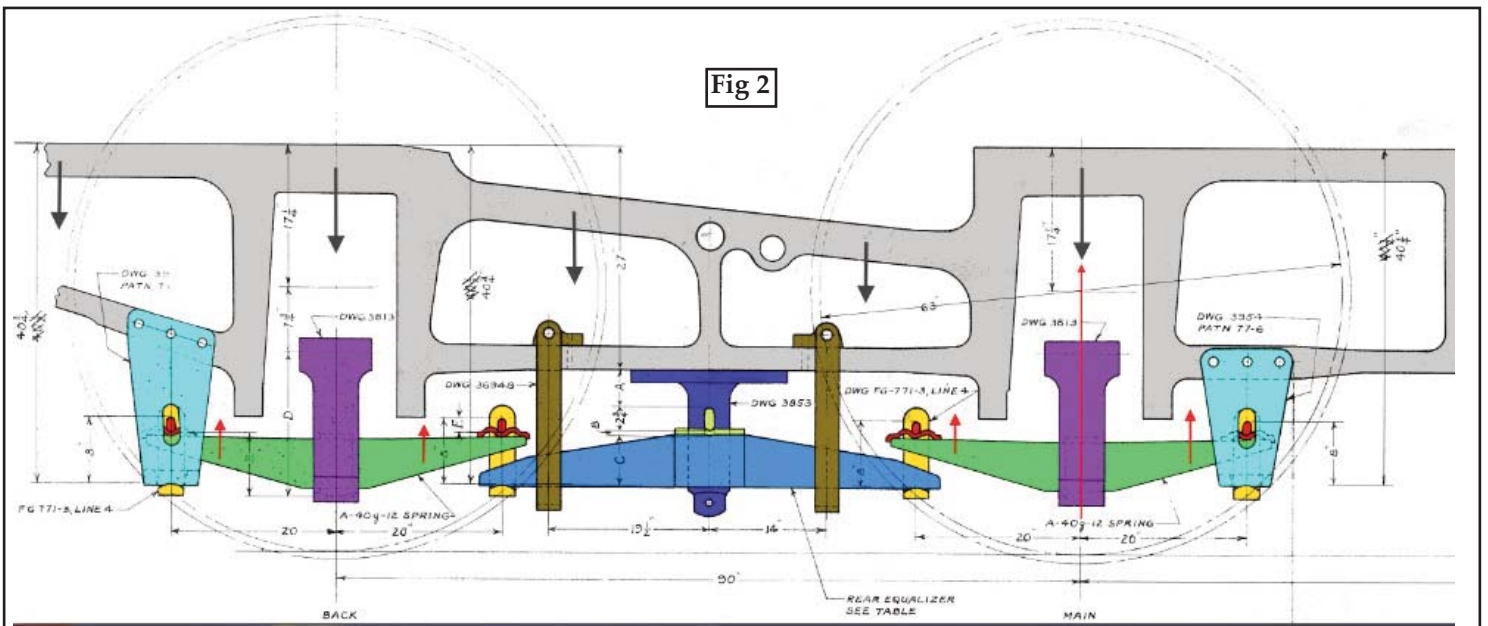
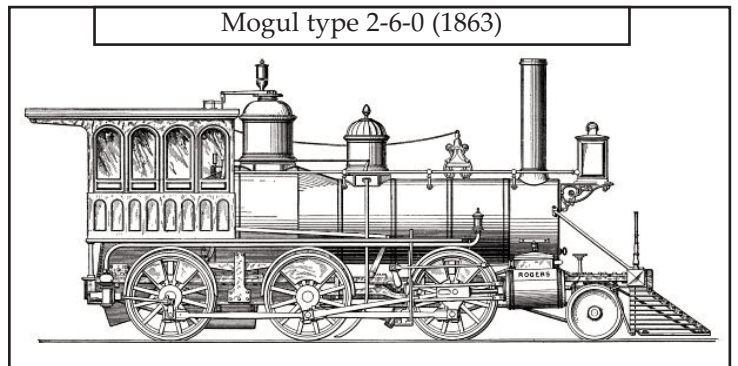
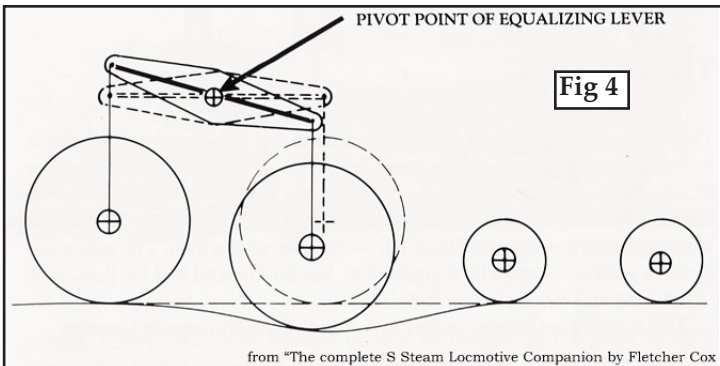

Fig 2



Graphics of the "Best Friend", "Experiment", "American type" and "Mogul type" are from an article "The Evolution of the American Locomotive" by Herbert T. Walker, the source being *Scientific American Supplement* - April 24, 1897. Fig. 4 comes from *The Complete Steam Locomotive Companion* by Fletcher Cox, text illustrations by Roy Bruce and Cathy Kelley, published by Thoughts in Focus, Alexandria, VA, 1987.

There was a demand for more powerful locomotives so one natural thing to try was to put more of the weight of the front of the locomotive on another set of driving wheels and take some off the front truck. This would mean putting another set of driving wheels where the rear wheels of the front "guiding truck" had been located. The result would be a 2-6-0 locomotive. How this was done is a story in itself and will be the topic in a future newsletter.

DRM at "Big E" for Railroad Hobby Show

The Museum staffed tables at its usual location near the snack concession in the Young building on the weekend of January 26-27. Much preparation was needed to prepare Gift Shop items for the show, amass modeling and library items for sale, then pack everything needed for display and sale. Once there, volunteers took turns at the Museum's table, selling merchandise, handing out flyers and newsletters, and otherwise publicizing our Museum and events. The event afforded the opportunity to shop and connect with other railroad enthusiasts and organizations. For the first time, there was a ceremony during which grants were awarded. Amherst Railway Society conducted a great show in the four buildings, attracting about 20,000 people, although somewhat fewer than in previous years. Our sales also were somewhat less, but this event represents much more than just immediate sales for the DRM. Our members highly anticipate the show each year.

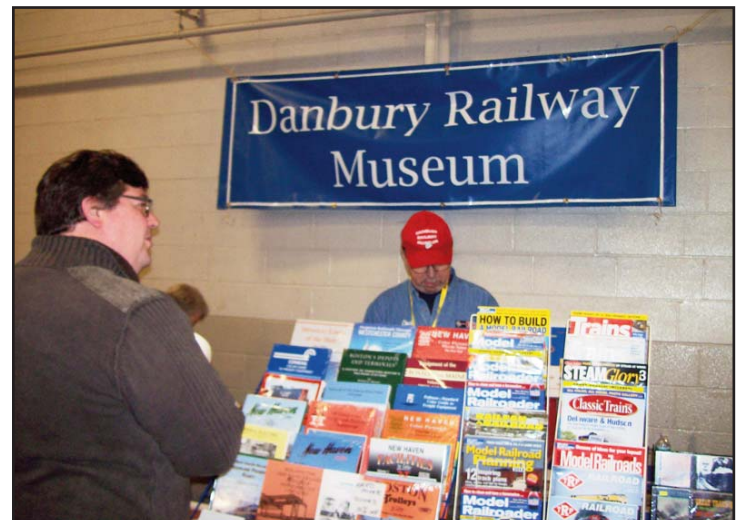
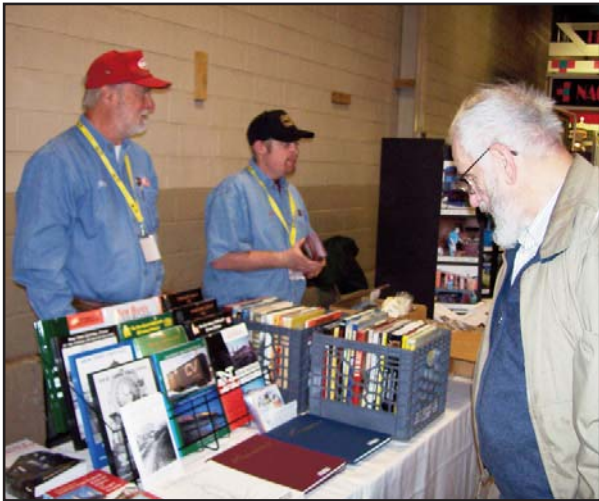

Calendar of Events 2013

Free programs and DRM weekly update, open to the public, every Wednesday, 7:30pm at the Museum
Train rides on weekends April - November, subject to availability

Sweetheart Trains - Take your sweetheart for a train ride, weather permitting	February 9 & 10
Bunny Trains - Trains rides to the Easter Bunny's special coach	March 23, 24, 29 & 30
National Train Day - Free train rides & other activities to be announced	May 11
Mother's Day - Moms ride free with child's paid admission	May 12
Memorial Day - Summer hours begin. Open 12-4pm with train rides.	May 27
Father's Day - Fathers ride free w/child's paid admission. Special caboose trains	June 16
July 4-	CLOSED
Danbury Railway Day & Member Picnic - Special Celebration with special activities	Date to be announced
Labor Day - Summer hours end. Open 12-4 with train rides	September 2
First Responders Day - Free admission & train rides to First Responders and their families	September 7
Owney, the Railway Post Office Dog Day - Stories, history, and children's activities to honor Owney, the famous RPO dog	September 21
Pumpkin Patch - Take a train ride to the Pumpkin Patch. Free pumpkin for children	October 12, 13, 19, 20, 26 & 27
Santa Trains - Train rides and visit Santa in his Special Coach	December 7, 8, 14, 15 & 21

Please note: Bunny Trains, Pumpkin Patch, and Santa Trains are special events, so pricing and scheduling may differ from regular events. All other events are attractions in addition to our regular weekend schedule of train rides. Visit us at www.danburyrail.org or contact the Museum at 203-778-8337 for an up-to-date schedule and information. Reservations are suggested for Bunny Trains and Santa Trains, and are available through our web site. Discounted admission for DRM members. All events are subject to change.

Museum Hours

Memorial Day - Labor Day: Monday - Saturday, 10-5pm, Sunday 12-5pm

Labor Day - Memorial Day: Wednesday - Saturday, 10-4pm, Sunday 12-4pm

Closed holidays except Memorial Day and Labor Day

Open 12-4pm Memorial Day and Labor Day

Hours may differ for holidays and special events



PO Box 90, DANBURY, CT 06813
Address Correction Requested

NONPROFIT ORGANIZATION
U.S. POSTAGE PAID
DANBURY, CT
PERMIT NO. 569

MUSEUM CALENDAR

- Mar 20(7:30pm) ANNUAL MEETING + Program
- Mar 21(7:00pm) Board Meeting - Open to Members
- Mar 27(7:30pm) A Day on the River Line - Stan Madyda
- Apr 3(7:30pm) NH Electrification - Carl Liba
- Apr 10(7:30pm) To be Announced - Steve Gould
- Apr 17(7:30pm) So African Rails - Ian Jenner
- Apr 18(7:00pm) Board Meeting - Open to Members
- Apr 24(7:30pm) To be Announced - Ron Smith
- May 1(7:30pm) Chi Stations + Terminals - Carl Liba

Museum hours: Wed-Sat 10-4; Sun 12-4

See the newsletter in color at www.danburyrail.org!



Contact Information

Please contact us with submissions:
 Mail: The Danbury Railway Museum
 Attention: Newsletter
 PO Box 90, Danbury, CT 06813
 Phone: 203.778.8337
 Fax: 203.778.1836
 Email: drmnewslettereditor@gmail.com
 Editor: Carolyn Taylor
 Printing by: Infinity Printing of Danbury

Change of Address

If you move, please send your change of address to:
 Danbury Railway Museum,
 Attention: Membership Chairman
 PO Box 90, Danbury, CT 06813
 Via Email to drmmembers@aol.com

